

Original instructions

ADA Cool

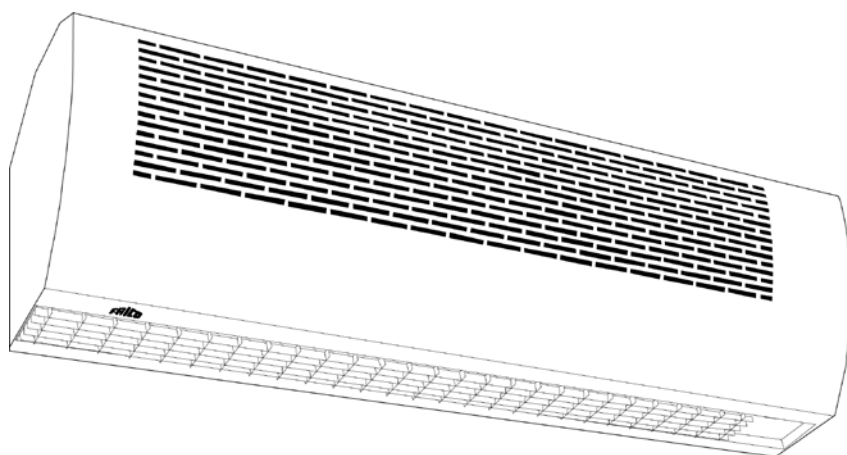

SE ... 4

GB ... 6

NO ... 8

FR ... 10

RU ... 12

DE ... 14

PL ... 16

FI ... 18

ES ... 20

NL ... 22

ADA Cool

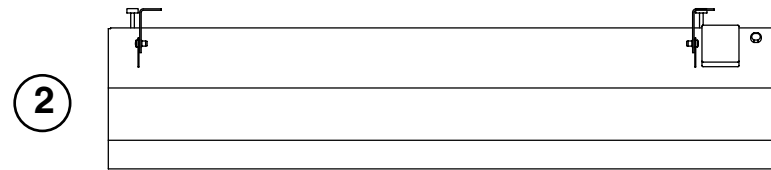
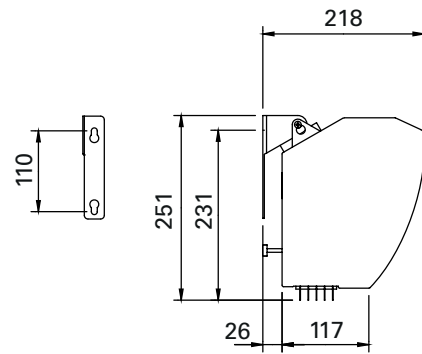
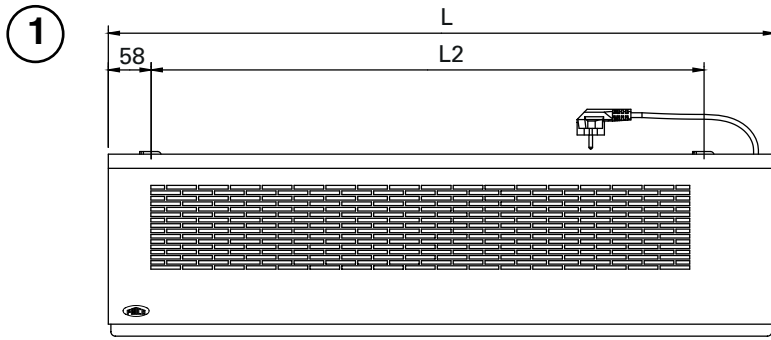

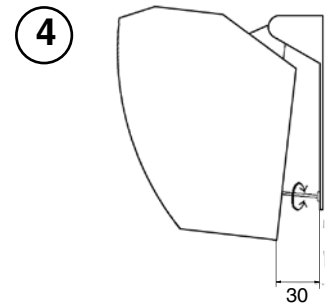
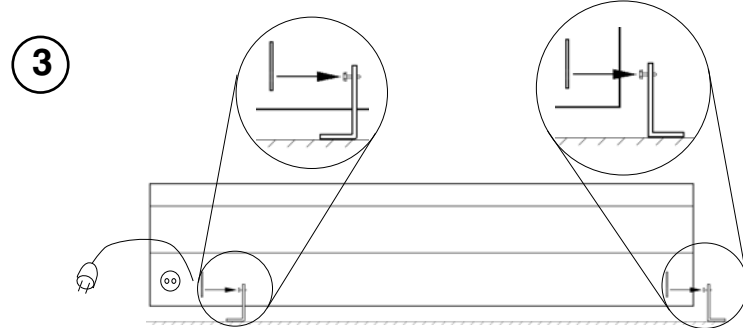

	L [mm]	L2 [mm]
ADAC090	900	747
ADAC120	1200	1047

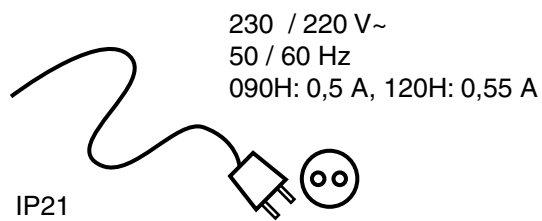
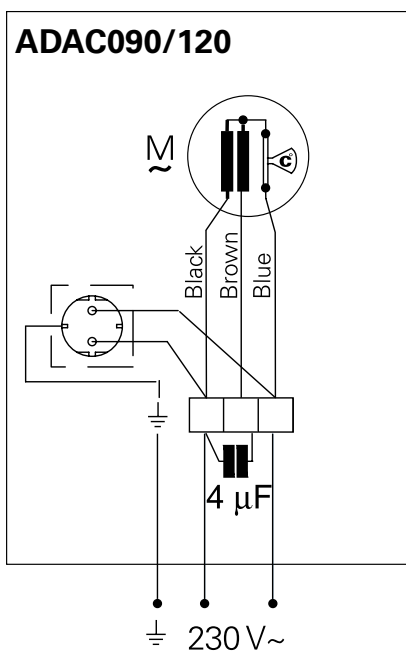
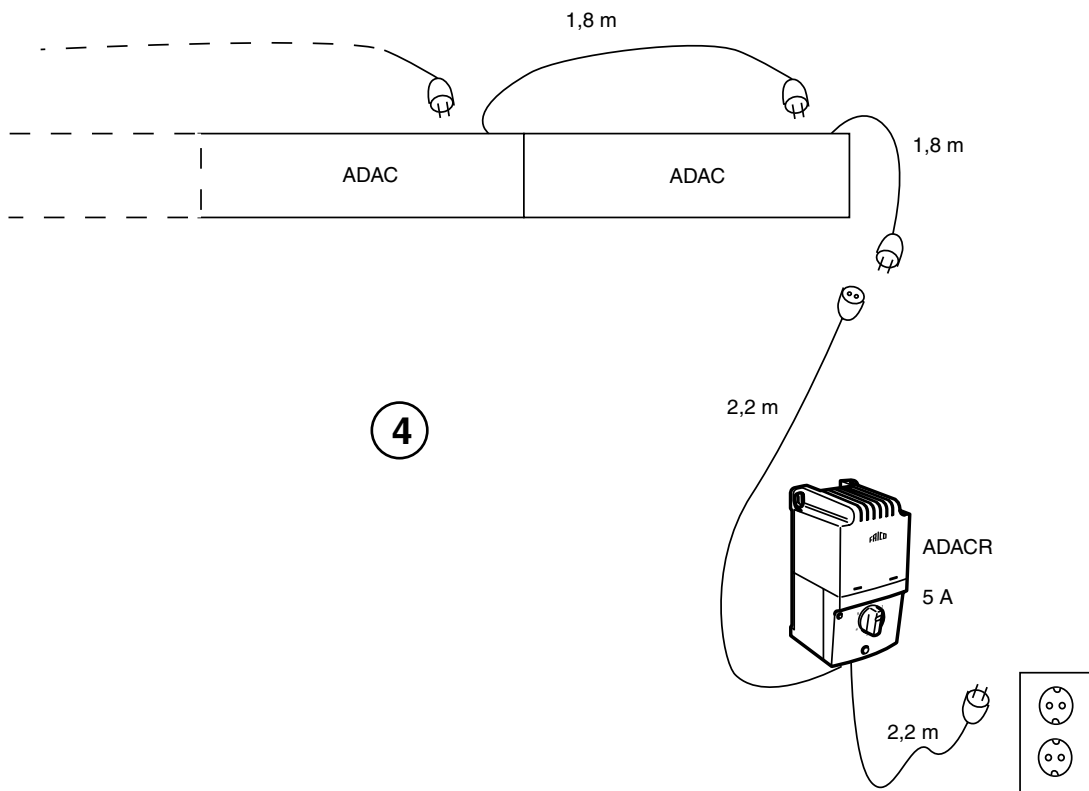

ADA Cool



			
ADAC090	1120	9,6	54
ADAC120	1400	11,8	51

Mounting and assembly instruction

General Instructions

Read these instructions carefully before installation and use. Keep this manual for future reference.

The product may only be used as set out in the assembly and operating instructions. The guarantee is only valid if the product is used in the manner intended and in accordance with the instructions.

Application area

ADAC air curtain is intended for permanent installation above cold store openings with heights of up to 2.5 metres. ADAC is used to keep the cold in cold stores and allow for open cold store areas. The unit creates an invisible barrier that prevents insects, fumes, dust and smells from entering the area. The ADAC units are easily linked to one another to cover wide openings. ADAC can also be mounted in false ceilings. Protection class: IP21

Operation

The air is drawn in at the top of the unit and blown out at high velocity across the doorway, providing a protective air shield. The air shield minimises cold draughts and reduces heat loss through open doorways. For best efficiency, the air curtain(s) should cover the whole width of the opening.

The unit can be angled and adjusted with the adjustment screw. The unit should normally be angled towards the warm side of the doorway. The fan speed is adjusted to the desired air flow (see accessory ADACR).

The efficiency of the air curtains depends on how large the draught stress is on the door.

Note! Negative pressure in the building considerably reduces the efficiency of the air curtain. Ventilation should therefore be balanced.

Mounting

ADAC is positioned on the warm side of the doorway. The units may only be installed horizontally with the air stream directed downwards. For the protection of wider doorways, several units can be mounted next

to each other. The air curtains are equipped with terminals for easy serial connection. Brackets for wall mounting are included on delivery.

1. Mount the brackets on the wall. Fig. 1.
2. Mount the unit on to the brackets and tighten the nuts. Fig. 2.
3. Set the adjustment screw according to Fig. 3. The distance between bracket and unit should be 30 mm in the standard setting.

For further details, see "Adjustment of ADA Cool".

Connection

ADAC is equipped with cable, plug and socket. This facilitates installation and serial connection of the units. Fig. 4. To complete the unit a regulation and connection set ADACR is needed.

Accessories

The unit needs to be completed by a regulation and connection set ADACR, consisting of a 5-stage regulator and cable. ADACR can regulate 7-9 units as a maximum (max. 7 units at 60Hz). Max. input: 5 A. Protection class: IP30. Fig. 4.

Safety

- Ensure that the area around the intake and exhaust grille is kept free from material which could prevent the air to flow through the unit!

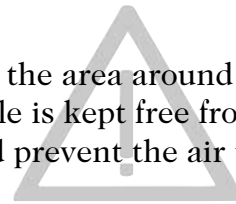

Maintenance

The fan motors and the other components require no maintenance other than cleaning when necessary, recommended at least once year. Grille and impeller are vacuum cleaned or wiped clean with a damp cloth.

Adjustment of ADA Cool

1. Set up the adjustment tool which could be ordered from Frico and attach the enclosed piece of paper.
2. The adjustment screw should be set on 30 mm in the standard setting. Fig. 3.
3. Put the adjustment tool on the floor, 0,5 m into the room on the cold side, see Figure to the right.
4. Adjust the speed with the 5-stage regulator (ADACR) so that the piece of paper is hanging straight down, not outwards or inwards. For further precise adjustment, adjust the angle of the unit through the adjustment screw. Fig. 3.

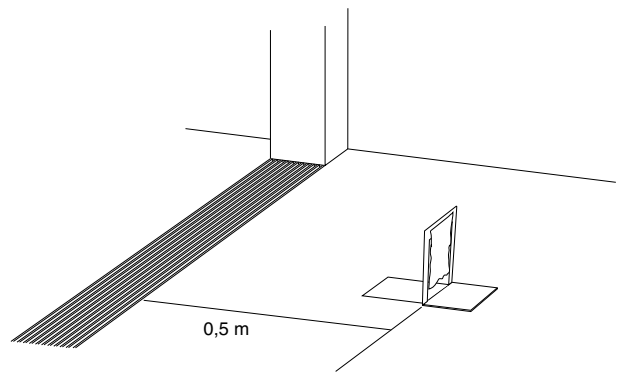

Positioning of adjustment tool

Theory

The air velocity in the air curtain must be great enough to direct the air stream downwards. The air curtain is mounted on the warm side and should be directed so that a small part of the air stream goes to the cold side while the main part blows towards the warm side. This ensures optimum separation of internal and external airs.

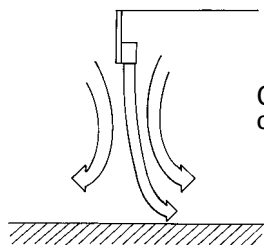
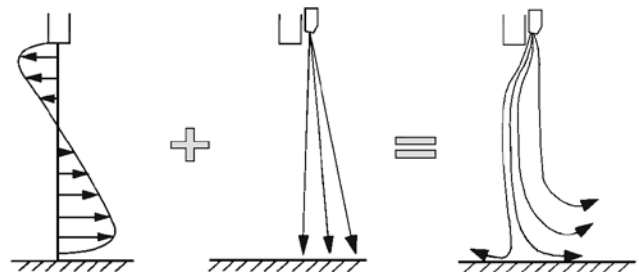

Correct air curtain!

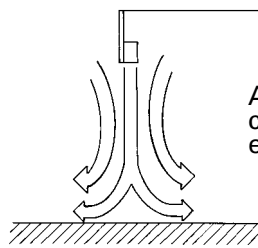

A too strong air curtain gives energy losses.

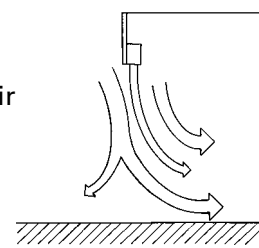

A too weak air curtain cannot cover the door height.

Measurements

The simulated environment was a cold storage room in a food store. The cold storage was directly connected to a room with room temperature. By carrying out a set of tests at different conditions, and by measuring the temperatures at different points in the air stream, charts were generated, showing how the air flow can affect the temperature in the different areas around the opening. The values on the x-axis indicate the distance in centimetres from the unit, the values on the y-axis indicate the distance in centimetres from the floor. When the air curtain is set correctly, a sharp division between the temperature zones is obtained.

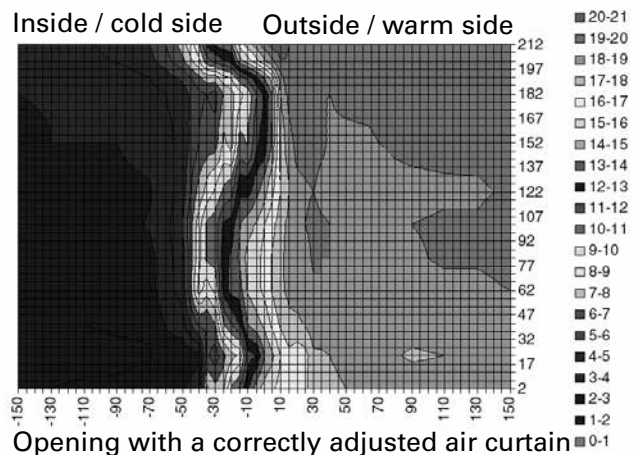

Opening with a correctly adjusted air curtain



Main office

Frico AB
Box 102
SE-433 22 Partille
Sweden

Tel: +46 31 336 86 00
Fax: +46 31 26 28 25
mailto:mailbox@frico.se
www.frico.se

**For latest updated information and information
about your local contact: www.frico.se**