

# 16

## WALL PROTECTION

New bumper without guides. Thanks to its big size and resistance it is ideal for protection of industrial spaces. Fixed caps with hidden screws covered by specific buttons.

Nuovo profilo antiurto senza guida. La sua ampiezza e resistenza lo rende ideale per la protezione di ambienti industriali. Terminali fissati con viti nascoste da appositi bottoni.

Nouveau profilé anti-choc sans besoin d'une base à fixer. Sa mesure large et sa résistance en font le profilé parfait pour la protection des espaces industriels. Embouts fixés avec des vis cachées grâce à des bouchons spécifiques.

Nuevo perfil antigolpe sin guía. Su amplitud y resistencia lo hacen ideal para la protección de entornos industriales. Terminales fijados con tornillos ocultos por botones especiales.



### Wall Protection

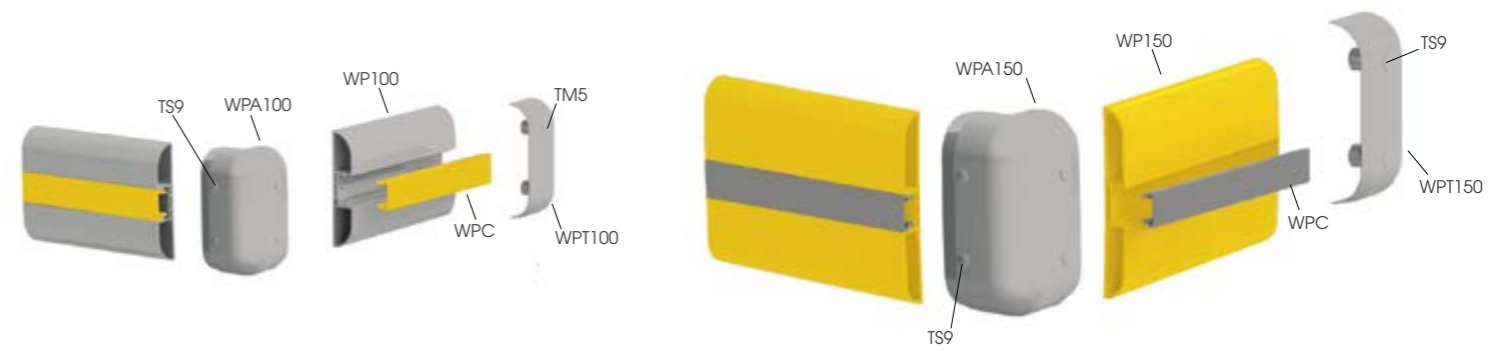

**WP 100**

Length **4.000 mm**  
Packing **8 pz / box**  
Colour **B E F**

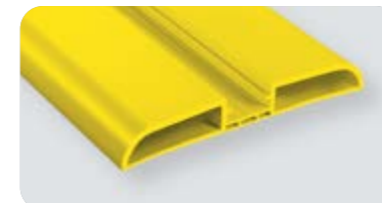
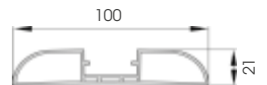

**WP 150**

Length **4.000 mm**  
Packing **4 pz / box**  
Colour **B M E**

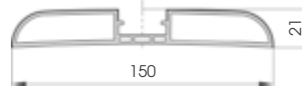

**WPC**

To install with WP 100 / WP 150

Length **4.000 mm**  
Packing **16 pz / box**  
Colour **A B M D E F G H**

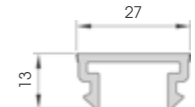

**WPT 100**

To install with TM5

Packing **50 pz / box**  
Colour **B E F**

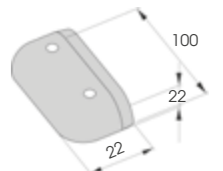

**WPA 100**

To install with TS9

Packing **20 pz / box**  
Colour **B E**

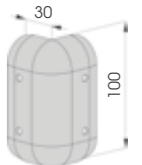

**WPT 150**

To install with TM5

Packing **50 pz / box**  
Colour **B E**

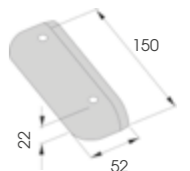

**WPA 150**

To install with TS9

Packing **20 pz / box**  
Colour **B E**

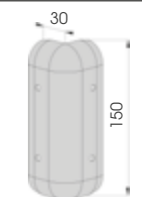

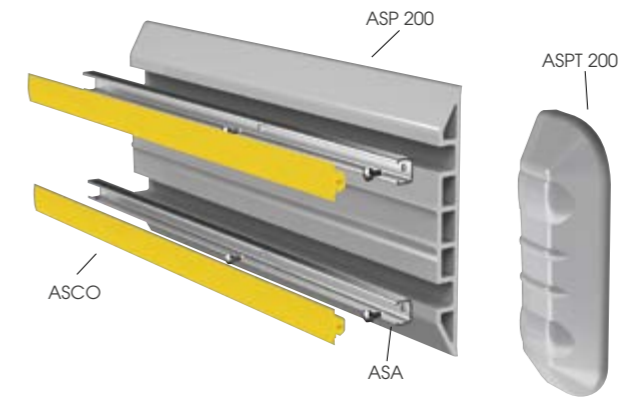
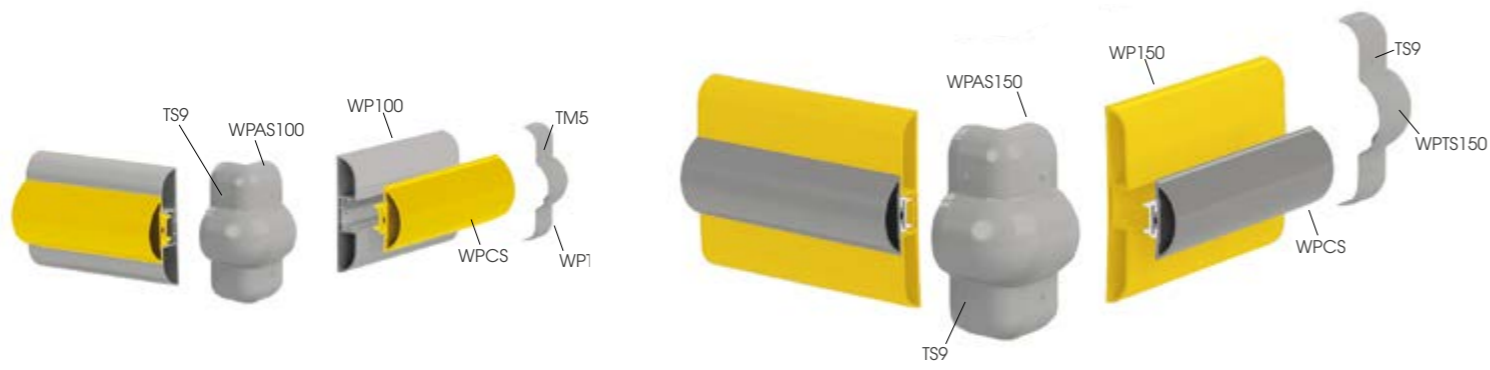

**WP 100**

Length **4.000 mm**  
Packing **8 pz / box**  
Colour **B E F**

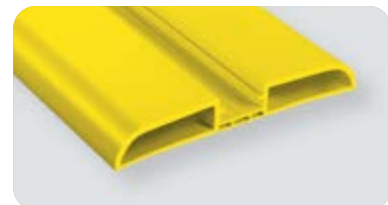
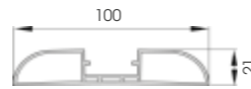

**WP 150**

Length **4.000 mm**  
Packing **4 pz / box**  
Colour **B M E**

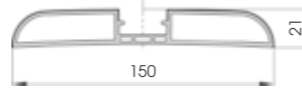

**WPCS**

To install with WP 100 / WP 150



Length **4.000 mm**  
Packing **8 pz / box**  
Colour **A B M D E F G H I**

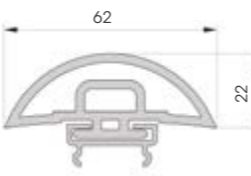

**WPTS 100**

To install with TS9

Packing **20 pz / box**  
Colour **B E**

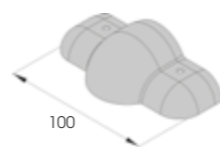

**WPAS 100**

To install with TS9

Packing **20 pz / box**  
Colour **B E**

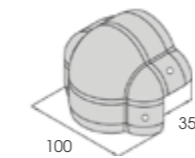

**WPTS 150**

To install with TS9

Packing **20 pz / box**  
Colour **B E**

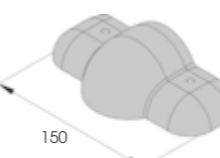

**WPAS 150**

To install with TS9

Packing **20 pz / box**  
Colour **B E**

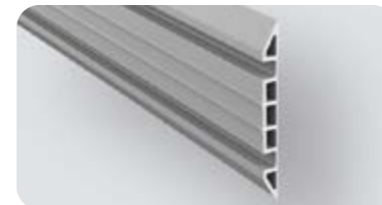
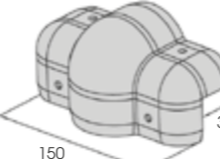

**ASP 200**



Length **4.000 mm**  
Packing **2 pz / box**  
Colour **B M**



**ASPT 200**



Packing **10 pz / box**  
Colour **B D**

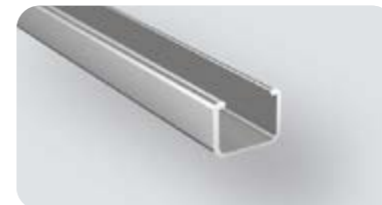
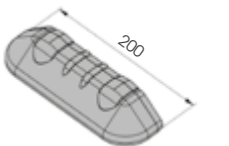

**ASA**

Material **aluminium**  
Length **4.000 mm**  
Packing **8 pz / bundle**



**ASCO**



Packing **2 pz / box**  
L = **32.000 mm**  
Colour **A B M D E**







**WALL HUG** 1000  
2000  
3000  
4000

Length 1000/2000/3000/4000  
Packing unpacked  
Colour M

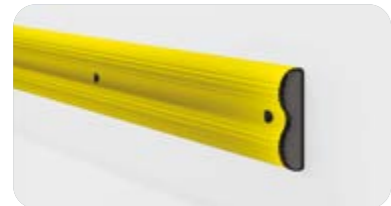
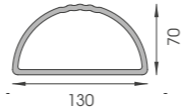

**WALL BFLEX** 1000  
2000  
3000  
4000

Length 1000/2000/3000/4000  
Packing unpacked  
Colour M

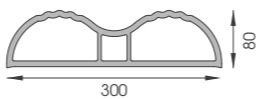

# NEWS



## LOFT BARRIER

WORLD'S FIRST FIXED PROTECTION SYSTEM FOR SUSPENDED AREAS

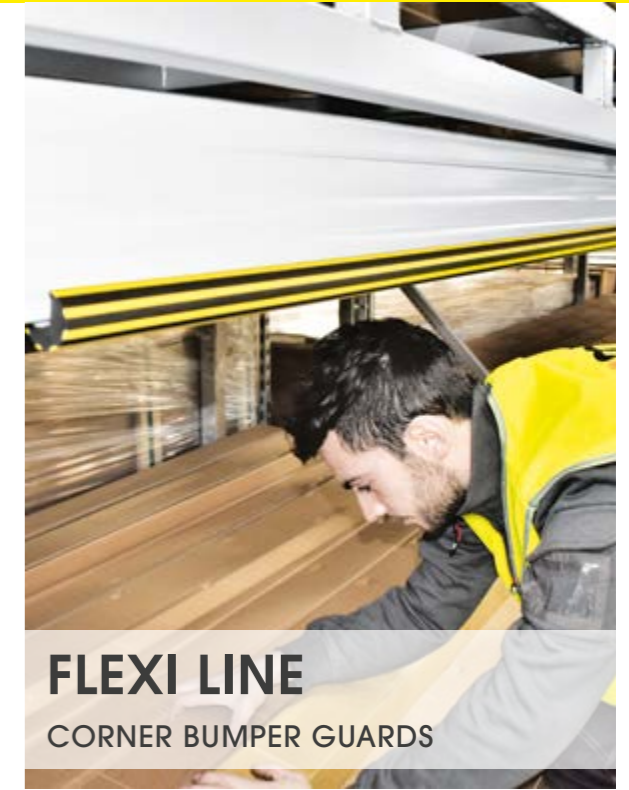

## FLEXI LINE

CORNER BUMPER GUARDS



## FENCE LINK

THE ADAPTABLE STRONGEST SOLUTION FOR RACK-ENDS

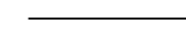

Now available  
**CUSTOMISED RACK PROTECTOR,**  
new version of rack protector  
processed upon request!

**CUSTOMISED RACK PROTECTOR**